

# GRAND PALAIS 180: G48

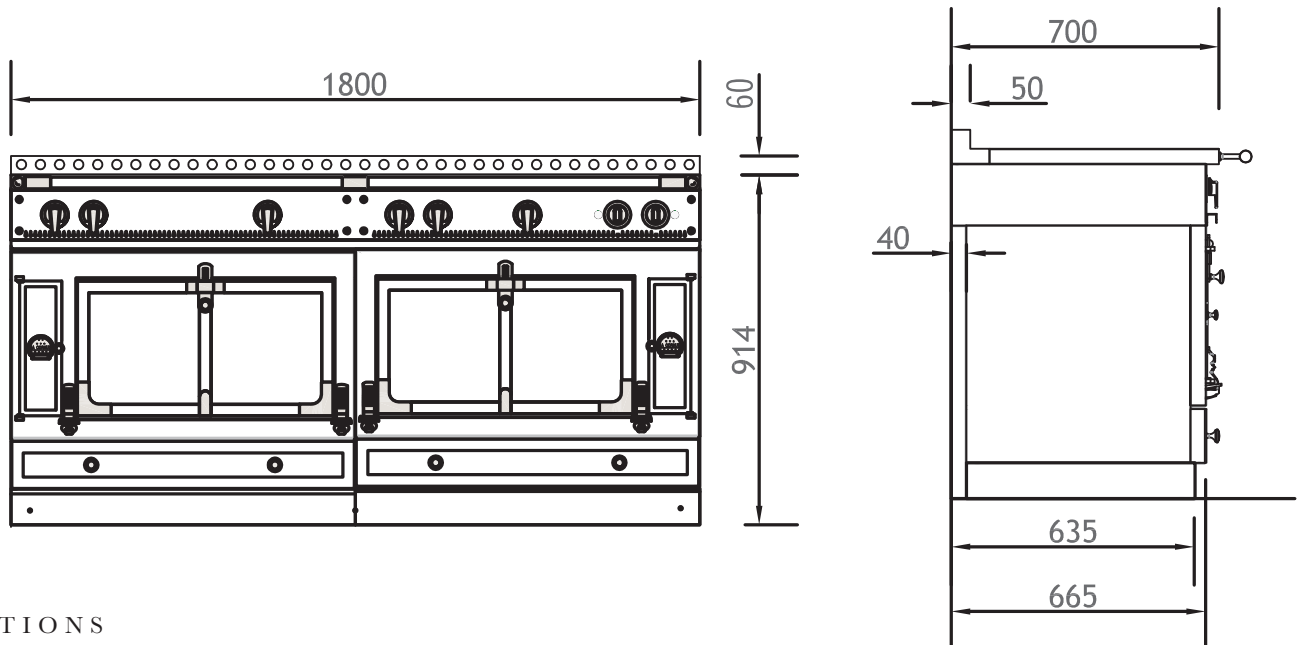

The Grand Palais 180 is the crown jewel of the Château Series, commanding respect and admiration in any kitchen. Almost 6 feet in length, the range boasts one grand vaulted gas oven and one grand vaulted electric oven, set beneath one of seven rangetop configurations.



## SPECIFICATIONS

### GRAND PALAIS 180: G48

1800 W x 700 D x 920 H (mm)  
 70.9 W x 27.6 D x 36 H (inches)  
 Approx. 710 lb. uncrated, 1320 lb. crated  
 Choice of 7 top configurations  
**Starting from \$56,300**

#### STANDARD FEATURES INCLUDE:

1 Grand Vaulted Gas Oven with Electric Broiler 22.6W x 19.8D x 11.8H – 3.1 cubic feet (left)  
 1 Grand Vaulted Electric Oven with Electric Broiler 22.6W x 17.5D x 11.8H – 2.7 cubic feet (right)

### GRAND PALAIS RANGETOP 180: T48

1800 W x 700 D x 200 H (mm)  
 70.9 W x 27.6 D x 7.9 H (inches)  
 Approx. 290 lb. uncrated, 450 lb. crated  
 Choice of 7 top configurations  
**Starting from \$23,900**

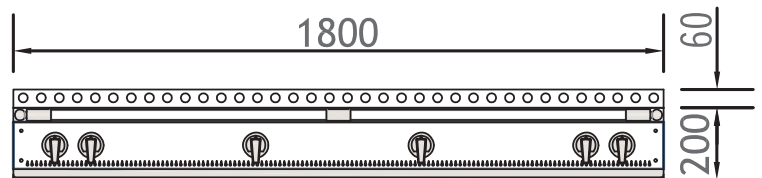

## LE CHÂTEAU OPTIONS

*Enamel and Metal Body Options:* Château ranges are available in a variety of 48 enamel or metal body finishes, and can also be customized in a one-of-a-kind color. Prices may vary depending on colors selected.

*Trim Options:* Polished Brass, Brushed Brass, Brushed Stainless Steel, Brushed Nickel, Polished Chrome, Polished Copper, Matte Black, Black Shiny Chrome, Bronze, Brushed Copper and Polished Stainless Steel.



# GRAND PALAIS 180: G48

## RANGETOP CONFIGURATIONS

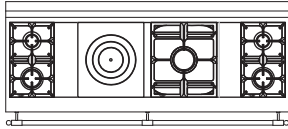

- 180 US N1**  
 2 gas burners (small burner at the back)  
 1 Plaque "French Top" (large)  
 1 maxi burner  
 2 gas burners (small burner at the back)

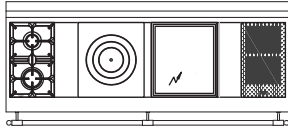

- 180 US N2\***  
 2 gas burners (small burner at the back)  
 1 Plaque "French Top" (large)  
 1 large electric Teppan-Yaki  
 2 induction plates

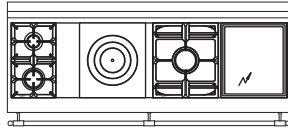

- 180 US N3**  
 2 gas burners (small burner at the back)  
 1 Plaque "French Top" (large)  
 1 maxi burner  
 1 large electric Teppan-Yaki

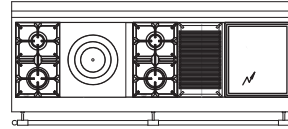

- 180 US N5**  
 2 gas burners (small burner at the back)  
 1 Plaque "French Top" (large)  
 2 gas burners (small burner at the back)  
 1 gas lava-rock grill  
 1 large electric Teppan-Yaki

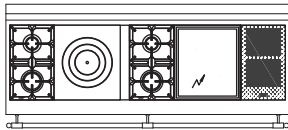

- 180 US N8\***  
 2 gas burners (small burner at the back)  
 1 Plaque "French Top" (large)  
 2 gas burners (small burner at the back)  
 1 large electric Teppan-Yaki  
 2 induction plates

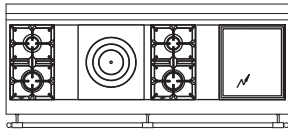

- 180 US N9**  
 2 gas burners (small burner at the back)  
 1 Plaque "French Top" (large)  
 2 gas burners (small burner at the back)  
 1 large electric Teppan-Yaki

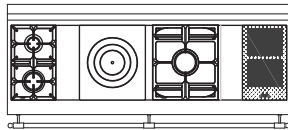

- 180 US NM\***  
 2 gas burners (small burner at the back)  
 1 Plaque "French Top" (large)  
 1 maxi burner  
 2 induction plates

\*Induction element incurs an upcharge of \$2,200 per element

## CHÂTEAU SERIES HOODS

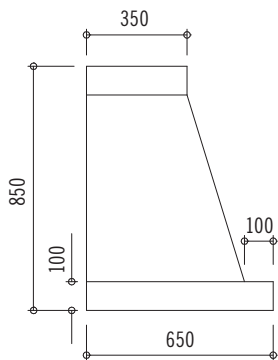

**Standard Configuration Wall Hood**  
 Side View

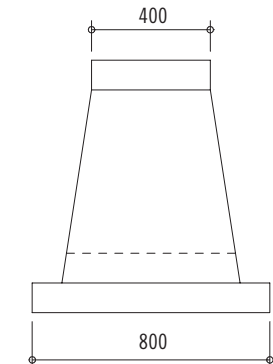

**Standard Configuration Island Hood**  
 Side View

Since every installation is unique, Hotte Chateau hoods are sold without a blower system, as a shell-only. Motorized hoods are available for standard wall-mounted Hotte Chateau. Please contact your local HVAC contractor to discuss specific installation requirements. La Cornue does offer standard Chateau hood models with blower option, as noted below. For custom inserts, please inquire with Purcell Murray directly.

Traditional wall mounted hood. Island Hoods are also available. Custom Hoods available by quote. Hood height may be increased up to 1500 mm/ 59 inches by adding height to the upper band (total maximum height would be 2250 mm/88.5 inches).

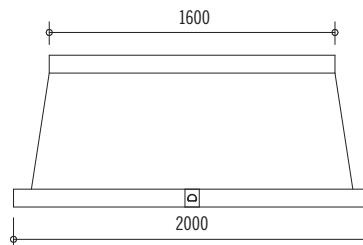

- HOTTE GRAND PALAIS 180: H20T0**  
 2000 W x 850 H x 650 D (mm)  
 78.7 W x 33.5 H x 25.6 D (inches)  
**Shell-Only Starting from \$12,200**  
**Mortorized Hood Starting from \$15,350**  
**Island configuration: H20C0**  
**Starting from \$20,900**

\*Motorized Factory installed blower and liner are available for the Chateau Hotte wall mounted hoods only. Motorized hoods include a 1200 CFM blower for all two oven cookers and a 600 CFM blower for all one oven cookers. They also include, liner, lights, mesh magnetic filters and a remote control.