

150: G45

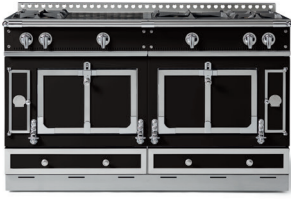

The Chateau 150 is the most popular Chateau range, a perfect balance of symmetry, design and function. With two standard vaulted ovens, one gas and one electric, the nearly 60" unit offers eight rangetop configurations to meet any culinary need. Inquire as well about the 53" Chateau 135, which includes a large vaulted oven (gas or electric) and a warming oven.

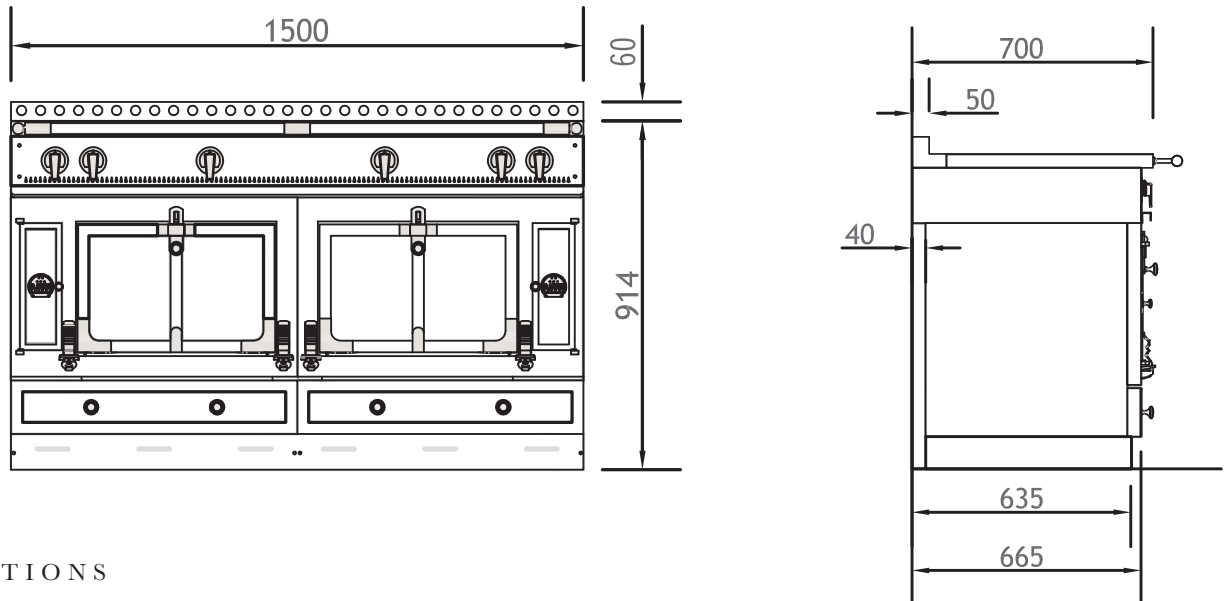

SPECIFICATIONS

CHÂTEAU 150: G45 & G44

1500 W x 700 D x 920 H (mm)
59.1 W x 27.6 D x 36 H (inches)
Approx. 620 lb. uncrated, 1230 lb. crated
Choice of 8 top configurations
Starting from \$48,800

STANDARD FEATURES INCLUDE:

1 Vaulted Gas Oven with Electric Broiler 16.8W x 19.8D x 11.8H – 2.3 cubic feet (left)
1 Vaulted Electric Oven with Electric Broiler 16.8W x 17.5D x 11.8H – 2.0 cubic feet (right)

CHÂTEAU RANGETOP 150: T45

1500 W x 700 D x 200 H (mm)
59.1 W x 27.6 D x 7.9 H (inches)
Approx. 290 lb. uncrated, 400 lb. crated
Choice of 5 top configurations
Starting from \$23,100

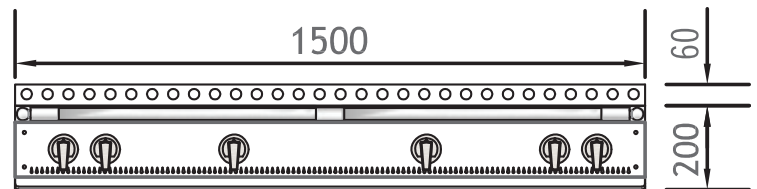

LE CHÂTEAU OPTIONS

Enamel and Metal Body Options: Chateau ranges are available in a variety of 48 enamel or metal body finishes, and can also be customized in a one-of-a-kind color. Prices may vary depending on colors selected.

Trim Options: Polished Brass, Brushed Brass, Brushed Stainless Steel, Brushed Nickel, Polished Chrome, Polished Copper, Matte Black, Black Shiny Chrome, Bronze, Brushed Copper and Polished Stainless Steel.



150: G45

RANGETOP CONFIGURATIONS

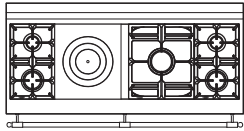

- 150 US K1**
 2 gas burners (small burner at the back)
 1 Plaque "French Top" (large)
 1 maxi burner
 2 gas burners (small burner at the back)

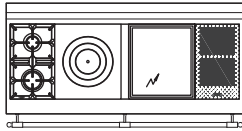

- 150 US K2***
 2 gas burners (small burner at the back)
 1 Plaque "French Top" (large)
 1 large electric Teppan-Yaki
 2 induction plates

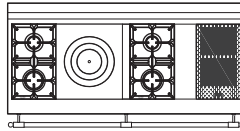

- 150 US K3***
 2 gas burners (small burner at the back)
 1 Plaque "French Top" (large)
 2 gas burners (small burner at the back)
 2 induction plates

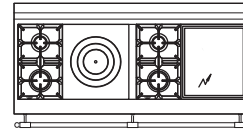

- 150 US K4**
 2 gas burners (small burner at the back)
 1 Plaque "French Top" (large)
 2 gas burners (small burner at the back)
 1 large electric Teppan-Yaki

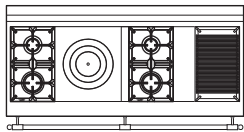

- 150 US K5**
 2 gas burners (small burner at the back)
 1 Plaque "French Top" (large)
 2 gas burners (small burner at the back)
 1 gas lava-rock grill

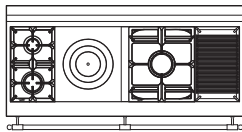

- 150 US K6**
 2 gas burners (small burner at the back)
 1 Plaque "French Top" (large)
 1 maxi burner
 1 gas lava-rock grill

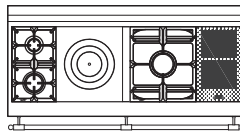

- 150 US KM***
 2 gas burners (small burner at the back)
 1 Plaque "French Top" (large)
 1 maxi burner
 2 induction plates

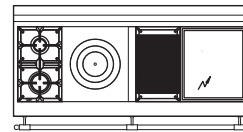

- 150 US KH**
 2 gas burners (small burner at the back)
 1 Plaque "French Top" (large)
 1 gas lava-rock grill
 1 large electric Teppan-Yaki

*Induction element incurs an upcharge of \$2,200 per element

CHÂTEAU SERIES HOODS

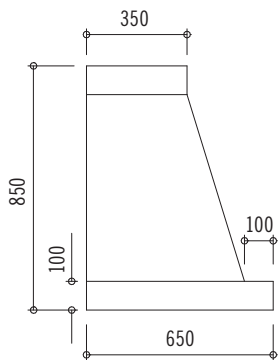

Standard Configuration Wall Hood
 Side View

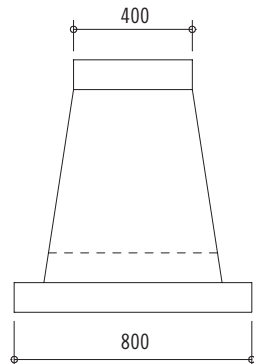

Standard Configuration Island Hood
 Side View

Since every installation is unique, Hotte Chateau hoods are sold without a blower system, as a shell-only. Motorized hoods are available for standard wall-mounted Hotte Chateau. Please contact your local HVAC contractor to discuss specific installation requirements. La Cornue does offer standard Chateau hood models with blower option, as noted below. For custom inserts, please inquire with Purcell Murray directly.

Traditional wall mounted hood. Island Hoods are also available. Custom Hoods available by quote. Hood height may be increased up to 1500 mm/ 59 inches by adding height to the upper band (total maximum height would be 2250 mm/88.5 inches).

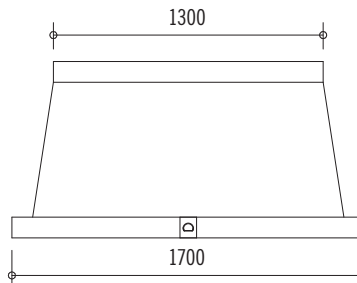

- HOTTE CHATEAU 150: H1770**
 1700 W x 850 H x 650 D (mm)
 66.9 W x 33.5 H x 25.6 D (inches)
Shell-Only Starting from \$10,700
Mortorized Hood Starting from \$13,450
Island configuration: H17C0
Starting from \$18,400

*Motorized Factory installed blower and liner are available for the Chateau Hotte wall mounted hoods only. Motorized hoods include a 1200 CFM blower for all two oven cookers and a 600 CFM blower for all one oven cookers. They also include, liner, lights, mesh magnetic filters and a remote control.