

## 165: G46

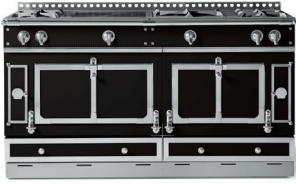

The Château 165 is born of a deep love of succulent roasted meats and poultry. At 65", the range features one grand vaulted gas oven and one vaulted electric oven, topped with a choice of five rangetop configurations.

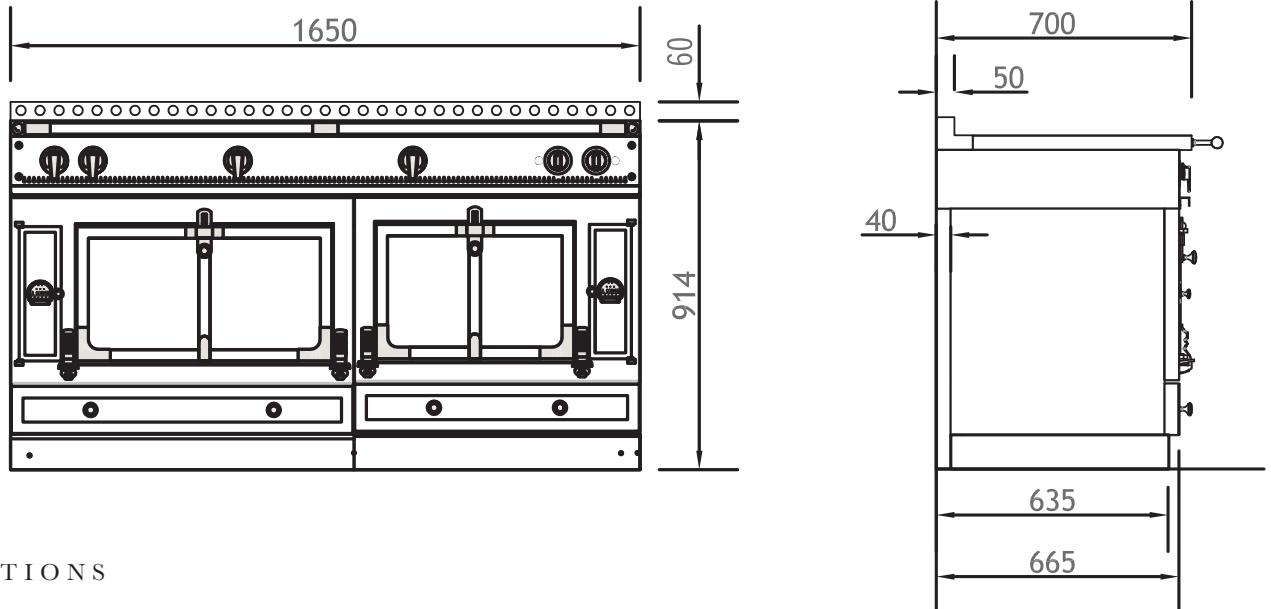

## SPECIFICATIONS

## CHÂTEAU 165: G46

1650 W x 700 D x 920 H (mm)  
65.0 W x 27.6 D x 36 H (inches)  
Approx. 640 lb. uncrated, 1280 lb. crated  
Choice of 5 top configurations  
**Starting from \$55,400**

## STANDARD FEATURES INCLUDE:

1 Grand Vaulted Gas Oven with Electric Broiler 22.6W x 19.8D x 11.8H – 3.1 cubic feet (left)  
1 Vaulted Electric Oven with Electric Broiler 16.8W x 17.5D x 11.8H – 2.7 cubic feet (right)

## CHÂTEAU RANGETOP 165: T46

1650 W x 700 D x 200 H (mm)  
65.0 W x 27.6 D x 7.9 H (inches)  
Approx. 290 lb. uncrated, 400 lb. crated  
Choice of 5 top configurations  
**Starting from \$24,200**

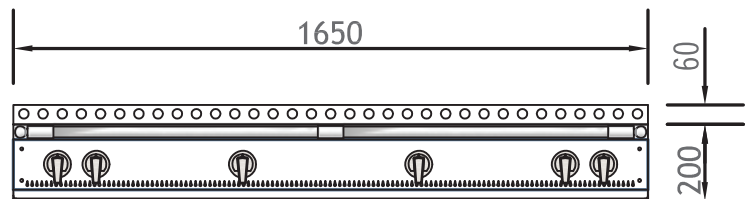

## LE CHÂTEAU OPTIONS

*Enamel and Metal Body Options:* Château ranges are available in a variety of 50 enamel or metal body finishes, and can also be customized in a one-of-a-kind color. Prices may vary depending on colors selected.

*Trim Options:* Polished Brass, Brushed Brass, Brushed Stainless Steel, Brushed Nickel, Polished Chrome, Polished Copper, Matte Black, Black Shiny Chrome, Matte Bronze, Brushed Copper and Polished Stainless Steel. Prices may vary depending on trims selected.



# 165: G46

## RANGETOP CONFIGURATIONS

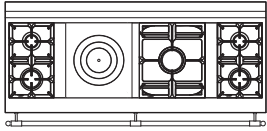

- 165 US L1**  
 2 gas burners (small burner at the back)  
 1 Plaque "French Top" (large)  
 1 maxi burner  
 2 gas burners (small burner at the back)

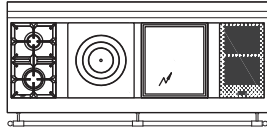

- 165 US L2\***  
 2 gas burners (small burner at the back)  
 1 Plaque "French Top" (large)  
 1 large electric Teppan-Yaki  
 2 induction plates

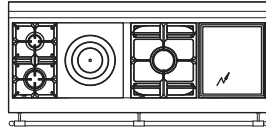

- 165 US L3**  
 2 gas burners (small burner at the back)  
 1 Plaque "French Top" (large)  
 1 maxi burner  
 1 large electric Teppan-Yaki

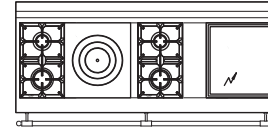

- 165 US L9**  
 2 gas burners (small burner at the back)  
 1 Plaque "French Top" (large)  
 2 gas burners (small burner at the back)  
 1 large electric Teppan-Yaki

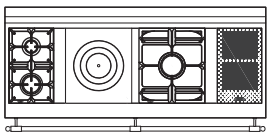

- 165 US LM\***  
 2 gas burners (small burner at the back)  
 1 Plaque "French Top" (large)  
 1 maxi burner  
 2 induction plates

\*Induction element incurs an upcharge of \$2,200 per element

## CHÂTEAU SERIES HOODS

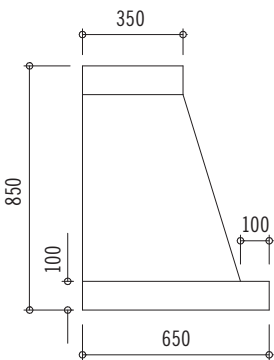

**Standard Configuration Wall Hood**  
Side View

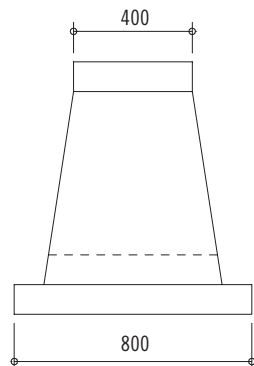

**Standard Configuration Island Hood**  
Side View

Since every installation is unique, Hotte Chateau hoods are sold without a blower system, as a shell-only. Motorized hoods are available for standard wall-mounted Hotte Chateau. Please contact your local HVAC contractor to discuss specific installation requirements. La Cornue does offer standard Chateau hood models with blower option, as noted below. For custom inserts, please inquire with Middleby Residential directly.

Traditional wall mounted hood. Island Hoods are also available. Custom Hoods available by quote. Hood height may be increased up to 1500 mm/ 59 inches by adding height to the upper band (total maximum height would be 2250 mm/88.5 inches).

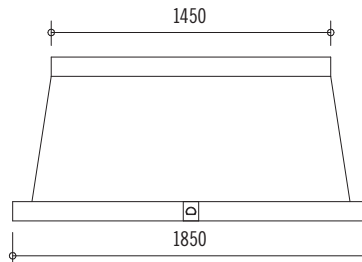

**HOTTE CHATEAU 165: H18T0**  
 1850 W x 850 H x 650 D (mm)  
 72.8 W x 33.5 H x 25.6 D (inches)  
**Shell-Only Starting from \$12,000**  
**Mortorized Hood Starting from \$15,200**  
**Island configuration: H18C0**  
**Starting from \$20,600**

\*Motorized Factory installed blower and liner are available for the Chateau Hotte wall mounted hoods only. Motorized hoods include a 1200 CFM blower for all two oven cookers and a 600 CFM blower for all one oven cookers. They also include, liner, lights, mesh magnetic filters and a remote control.